

1
7.2.1 PLAN
3" = 1'-0"

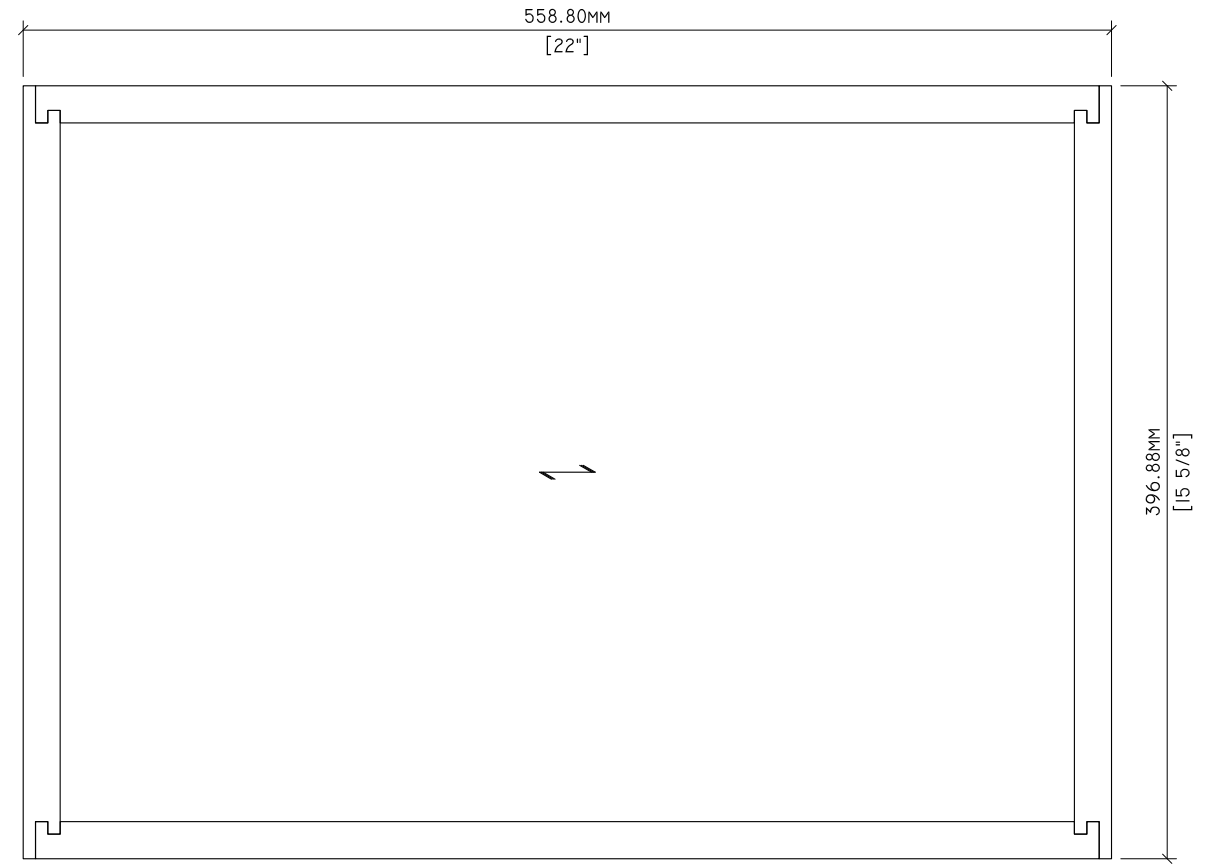

2
7.2.1 PLAN - BOTTOM
3" = 1'-0"



**Standards Development and
Performance Testing**
1310 Southerfield Road
Americus, GA 31709

Drawn By:	HD	REVISIONS		SPECIMEN DWG. NO.: 7.2.1
Reviewed By:	-	①	-	JOINERY METHOD NO.: LOCK JOINT
Revised By:	-HKM	②	-7/30/2020	SPECIMEN MATERIAL: 3/4" M2 PARTICLE BOARD
Revised By:	-	③	-	BATCH QUANTITY: N/A
Approved By:	-	④	-	SCALE: AS NOTED

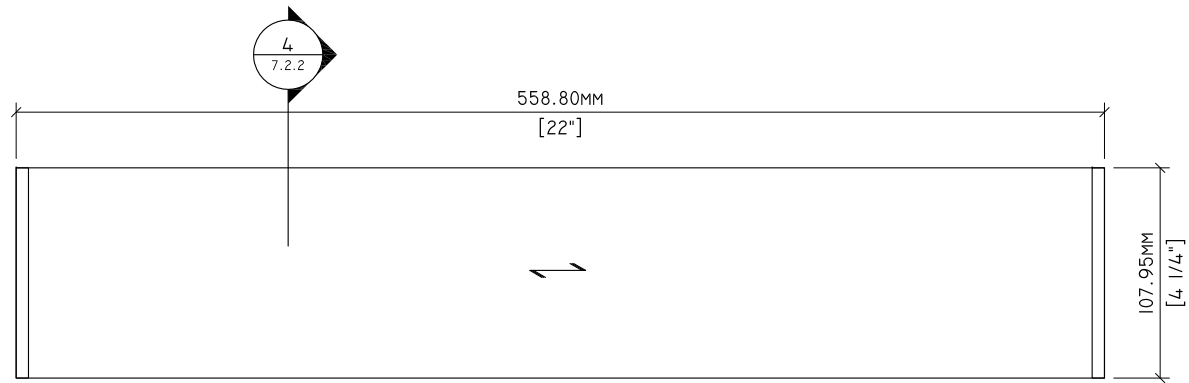

1 ELEVATION
7.2.2 3" = 1'-0"

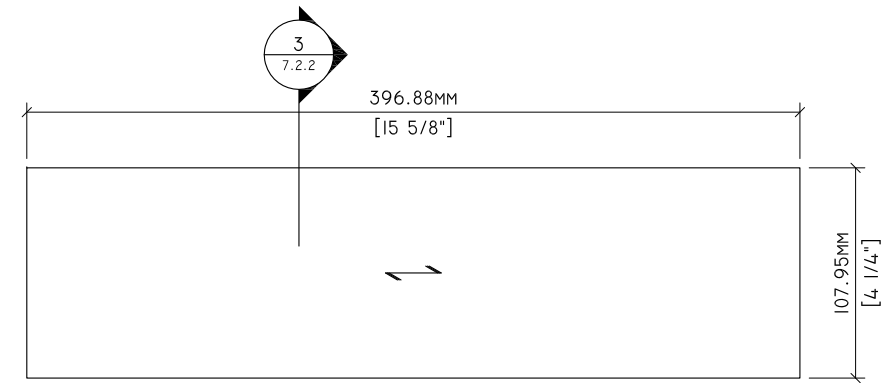

2 ELEVATION
7.2.2 3" = 1'-0"

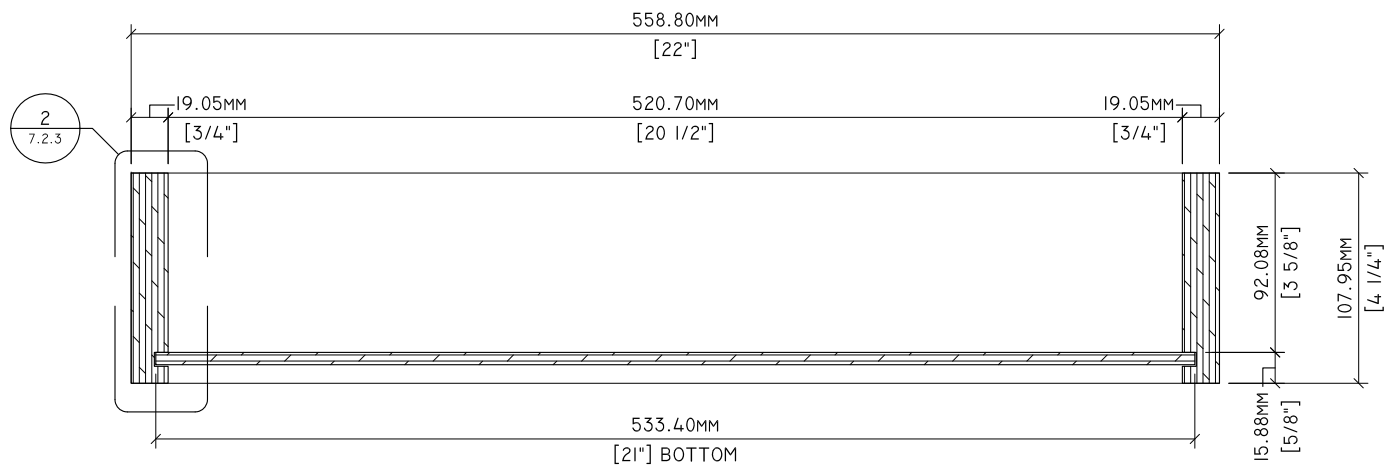

3 SECTION
7.2.2 3" = 1'-0"

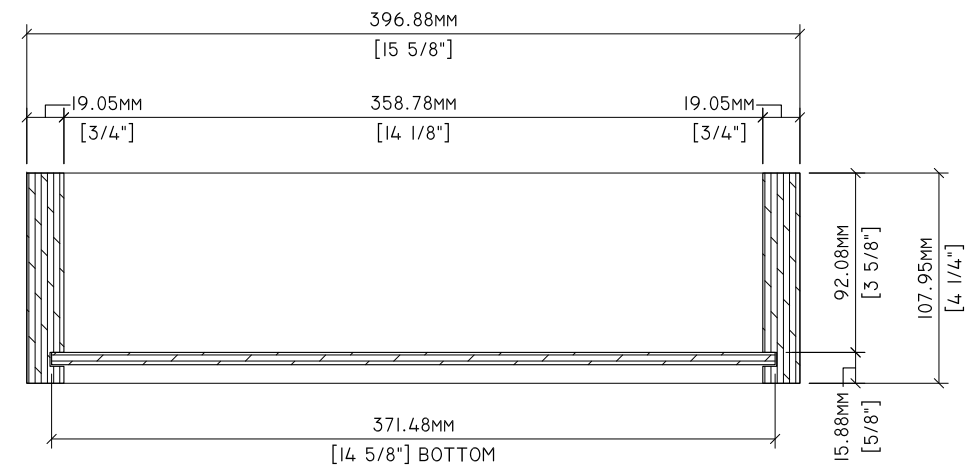

4 SECTION
7.2.2 3" = 1'-0"

Drawn By:	HD	REVISIONS		SPECIMEN DWG. NO.: 7.2.2
Reviewed By:	-	①	-	JOINERY METHOD NO.: LOCK JOINT
Revised By:	-HKM	②	-7/30/2020	SPECIMEN MATERIAL: 3/4" M2 PARTICLE BOARD
Revised By:	-	③	-	BATCH QUANTITY: N/A
Approved By:	-	④	-	SCALE: AS NOTED

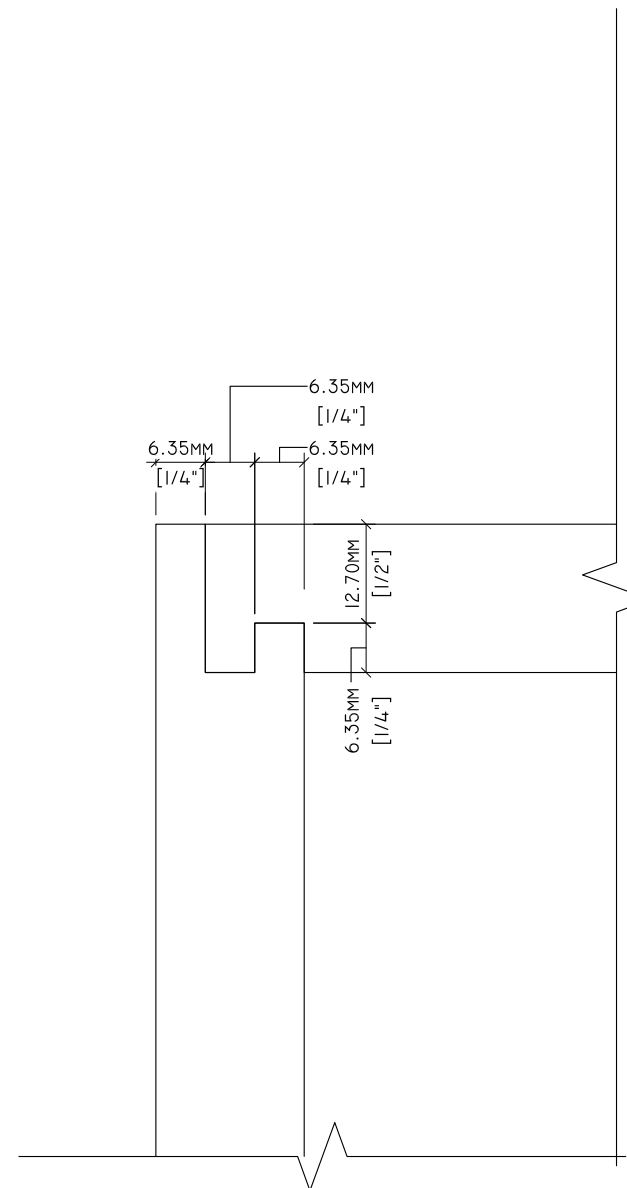

1
7.2.3 12" = 1'-0"

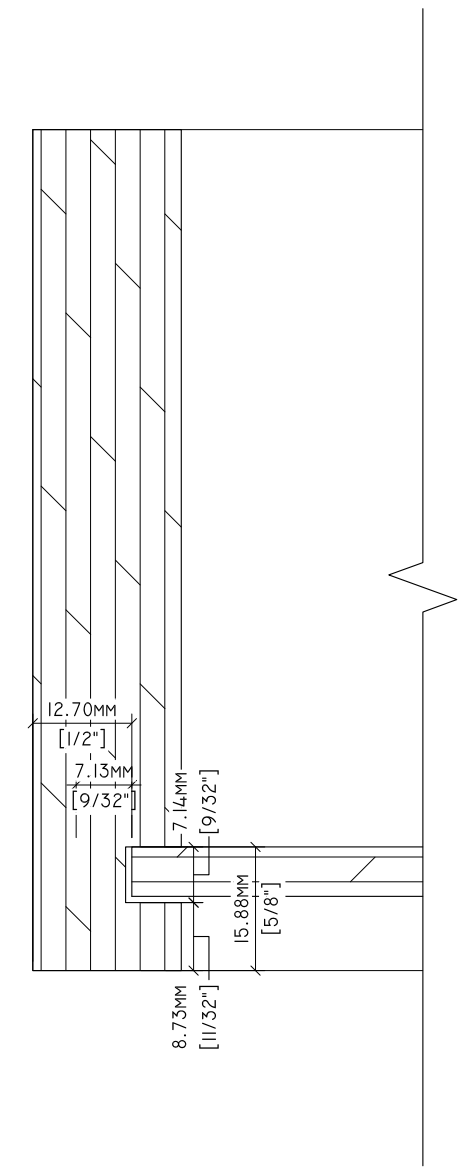

2
7.2.3 12" = 1'-0"



Standards Development and Performance Testing
 1310 Southerfield Road
 Americus, GA 31709

Drawn By:	HD	REVISIONS	
Reviewed By:	-	①	-
Revised By:	-HKM	②	-7/30/2020
Revised By:	-	③	-
Approved By:	-	④	-

SPECIMEN DWG. NO.:	7.2.3
JOINERY METHOD NO.:	LOCK JOINT
SPECIMEN MATERIAL:	3/4" M2 PARTICLE BOARD
BATCH QUANTITY:	N/A
SCALE:	AS NOTED